

男子団体(34)

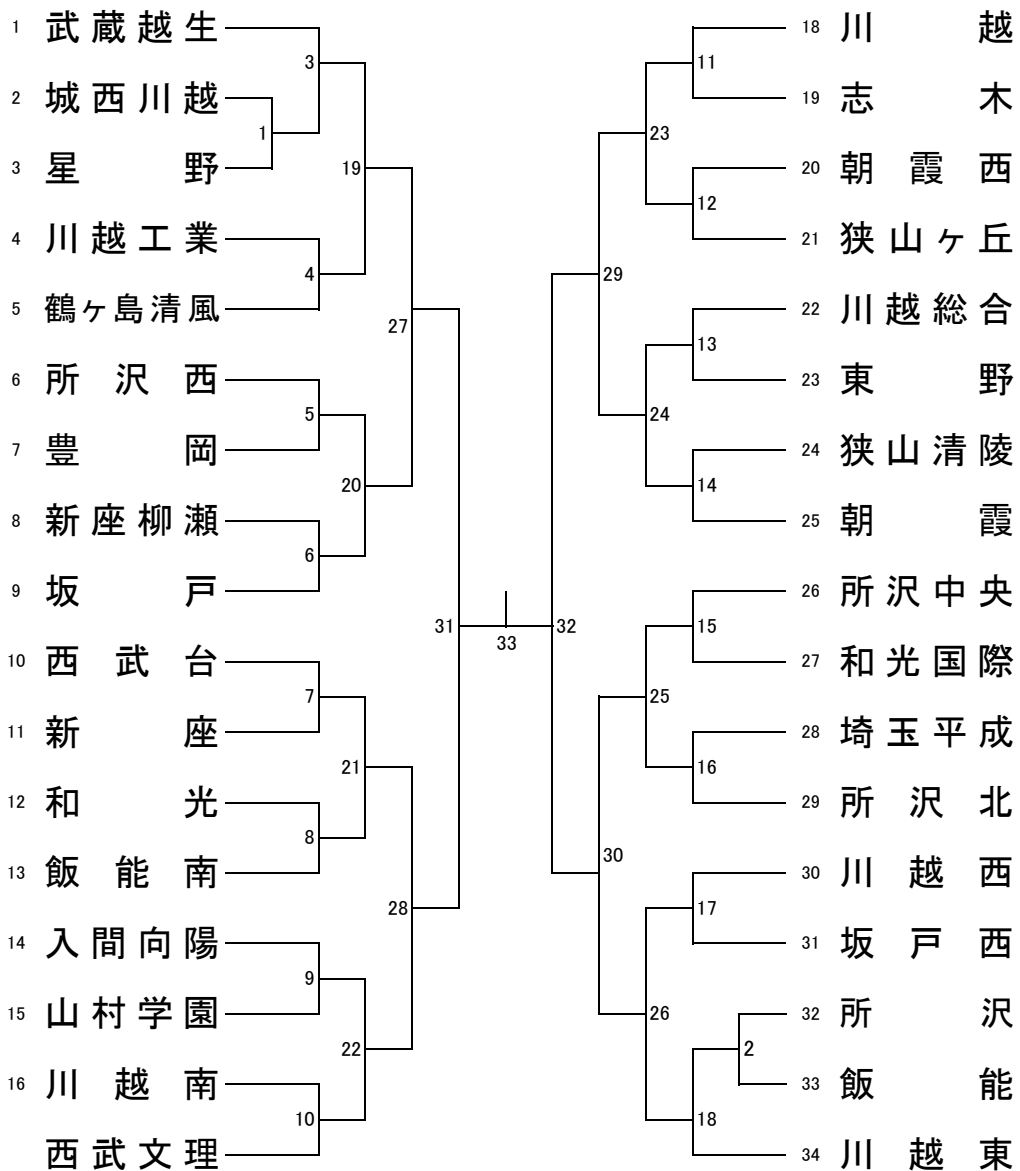

3位決定戦

5位決定戦

7位決定戦

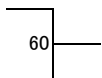
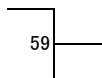
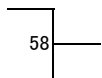

リーグ戦参加決定戦

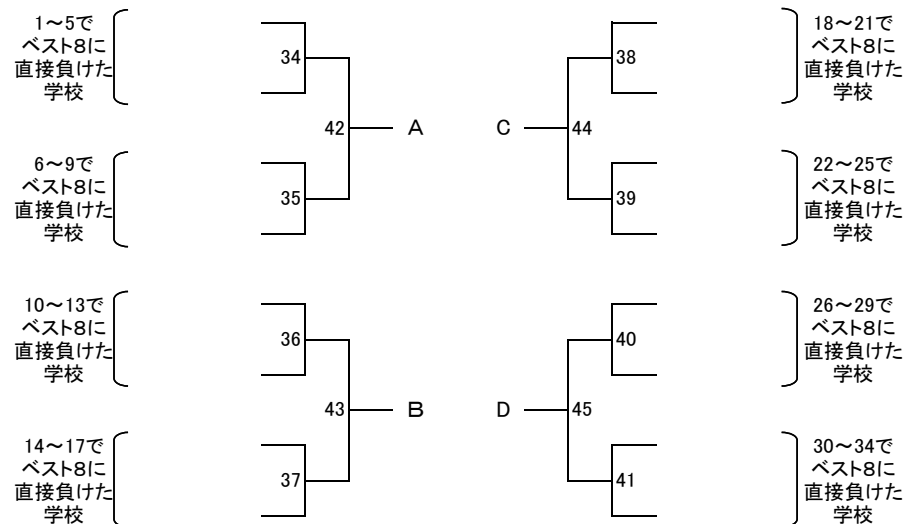

県大会出場決定リーグ戦

					勝敗	順位
1~9でB8		50	48	46		
10~17でB8			47	49		
A				51		
B						

					勝敗	順位
18~25でB8		56	54	52		
26~34でB8			53	55		
C				57		
D						