

男子団体(30)

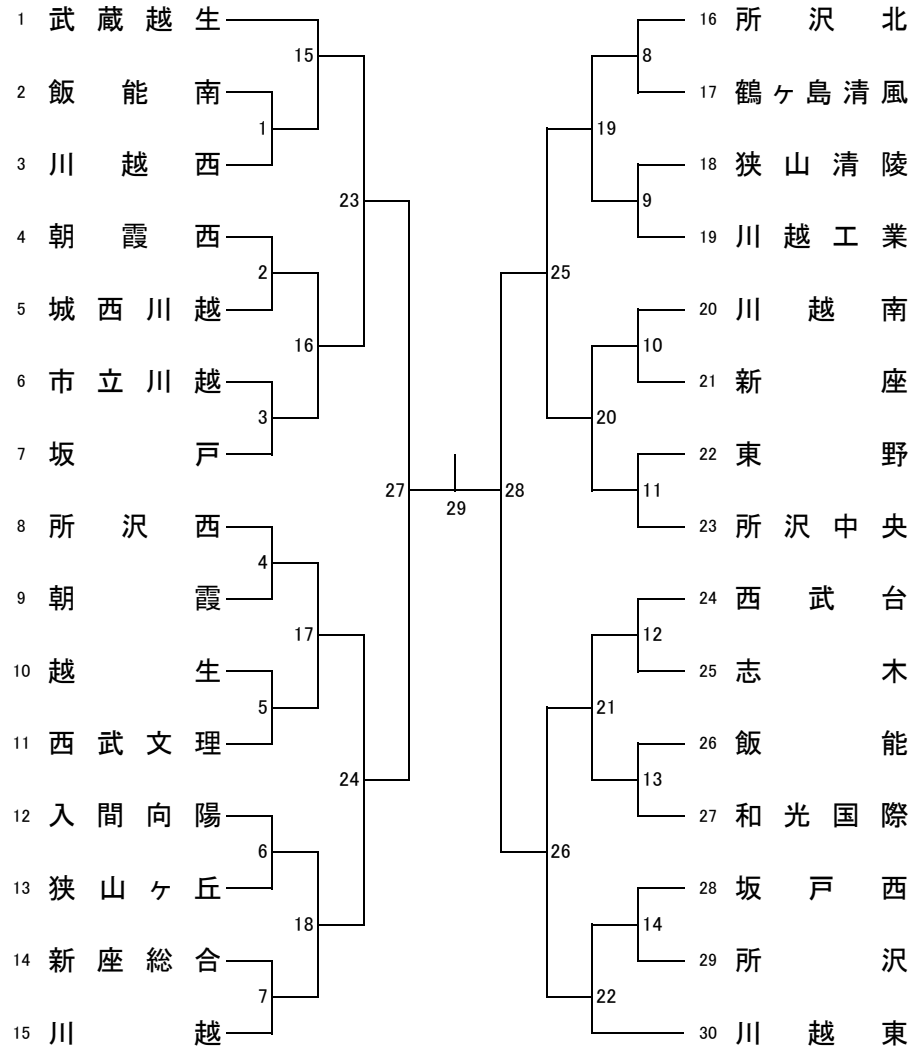

3位決定戦



5位決定戦



7位決定戦

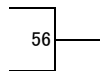

リーグ戦参加決定戦

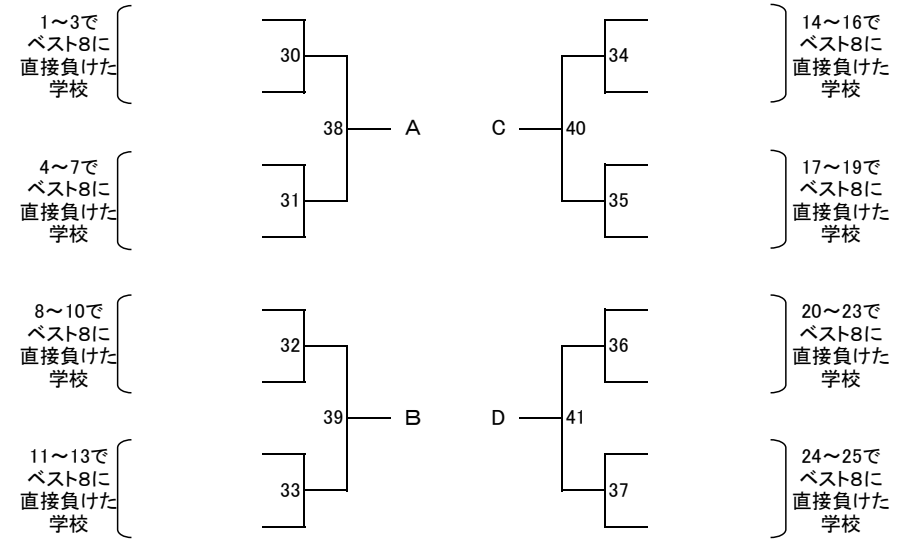

県大会出場決定リーグ戦

				勝敗	順位
1~7でB8	46	44	42		
8~13でB8		43	45		
A			47		
B					

				勝敗	順位
14~19でB8	52	50	48		
20~25でB8		49	51		
C			53		
D					